



User Manual

Pro O₂ Alarm

Oxygen Analyzer

Rev. 07.18

If you have any questions on this equipment please contact Technical Support at:

Nuvair
1600 Beacon Place
Oxnard, CA 93033

Phone: +1 805 815 4044
FAX: +1 805 486 0900
Email: info@nuvair.com

Hours: Monday through Friday
8:00 AM to 5:00 PM PST USA

Warning

This User Manual contains important safety information and should always be available to those personnel operating this equipment. Read, understand, and retain all instructions before operating this equipment to prevent injury or equipment damage.

Every effort was made to ensure the accuracy of the information contained within this manual; however, we retain the right to modify its contents without notice. If you have problems or questions after reading the manual, stop and call for information.

Table of Contents

1.0 Introduction	4
2.0 System Description	5
2.1 Controls	6
2.2 Display	6
2.3 Alarm	6
2.4 Sensor	6
2.5 Batteries	6
2.6 Flow Adapter Cap	7
3.0 Calibration	7
3.1 Calibration Methods	8
4.0 Operation.....	8
4.1 Programming Procedures	9
4.2 Alarm Setting	10
4.3 Full Scale Value Setting	10
4.4 Calibration Oxygen Value	11
5.0 Threshold Alarms	11
6.0 Powering on and warming up	12
6.1 Powering Off.....	12
7.0 Factory Reset	12
8.0 Maintenance.....	13
8.1 Analyzer Care	13
8.2 Battery Replacement	14
8.3 Sensor Replacement	14
8.4 Handling Sensors	15
9.0 Sensors	17
10.0 Troubleshooting.....	17
11.0 Spares and accessories	18
12.0 Relay Output Schematics.....	19
Warranty	20

1.0 Introduction

This manual will assist you in the proper set-up, operation and maintenance of the Pro O₂ Alarm™ Oxygen Analyzer. Be sure to read the entire manual.

Throughout this manual we will use certain words to call your attention to conditions, practices or techniques that may directly affect your safety. Pay particular attention to information introduced by the following signal words:

Danger

Indicates an imminently hazardous situation, which if not avoided, will result in serious personal injury or death.

Warning

Indicates a potentially hazardous situation, which if not avoided, could result in serious personal injury or death.

Caution

Indicates a potentially hazardous situation, which if not avoided, may result in minor or moderate injury. It may also be used to alert against unsafe practices.

Notice

Notifies people of installation, operation or maintenance information which is important but not hazard-related.

Warnings Graphics Defined:

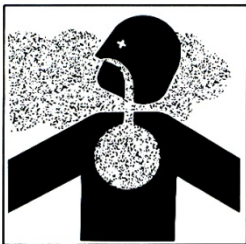

Gas Inhalation



Skin damage

2.0 System Description

The Pro O₂ Alarm™ Oxygen analyzer measures oxygen (O₂) levels in gases in the range of 0.0 to 100%. The Analyzer is designed to verify O₂ concentration in stored gas cylinders, enclosed spaces and with compressors pumping nitrox. When used in breathing gas applications, redundant Analyzers must be used for verification. In diving, for example, one Analyzer must be used to monitor oxygen during breathing gas production and a second independent Analyzer must be used to verify the oxygen content of the breathing gas prior to diver use.

Warning

When using the Analyzer for diving applications with mixed gases other than air, you must first obtain proper instruction from a certified diving instructor with a nationally recognized training agency qualified in mixed gas diving. Improper use of this analyzer may result in incorrect gas analysis which can lead to serious personal injury or death.

The Analyzer is battery powered and includes an internally mounted Sensor with audible alarm. The Water-Resistant Case includes a Digital Display and controls that are environmentally sealed

The Analyzer uses a Flow Adapter Cap and Flexible tubing to deliver sample gas to the Sensor. Pressurized gases must be regulated to avoid damage to the analyzer. Use of this Analyzer in a hyperbaric chamber will void the owner's warranty.

The Analyzer comes in a high impact storage case. It is ready for use after calibration with an appropriate certified calibration gas.

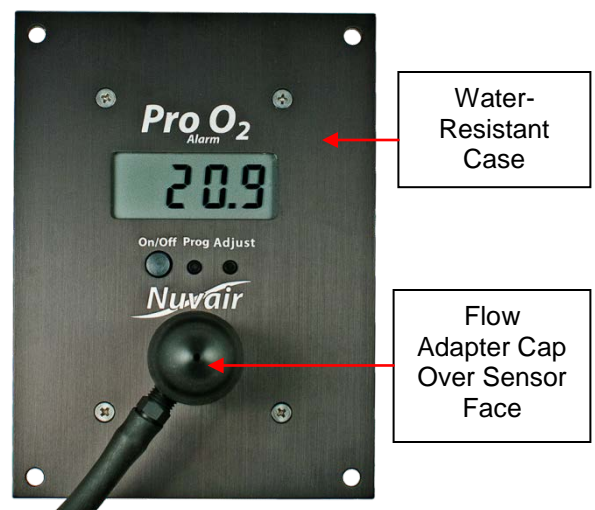

Warning

This analyzer is designed for use at atmospheric pressures only. It is not designed for exposures in a hyperbaric chamber. Use of this analyzer in a hyperbaric chamber will result in incorrect readings and may damage the unit.

Warning

Although the Analyzer is a rugged instrument, careless handling or abuse may result in damage to the Analyzer resulting in inaccurate gas analysis. Inaccurate gas analysis can lead to serious personal injury or death.

Warning

Breathing gas must always be analyzed by two separate Analyzers, with one used for production and one used for analysis after production. Never depend on a single Analyzer during both gas production and delivery. If the Analyzer readings do not agree, both units must be recalibrated. Inaccurate gas analysis can lead to serious personal injury or death.

2.1. Controls

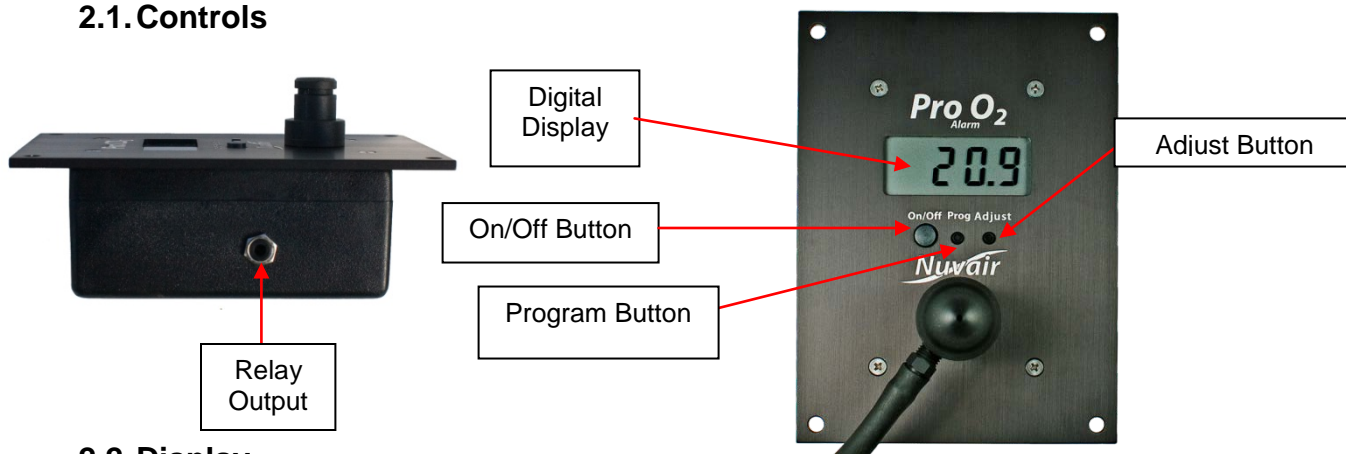

2.2. Display

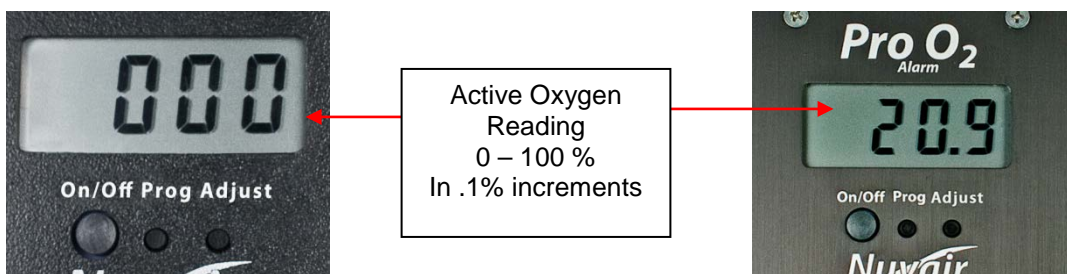

2.3. Alarm

The Analyzer includes an audible alarm that is activated when the sensor reaches a user programmed minimum % of oxygen and maximum % of oxygen. The alarm will not clear until the concentration of O₂ moves into the threshold programmed by the user.

2.4. Sensor

The Analyzer uses an electrochemical O₂ sensor to measure O₂ content in gases. The sensor is disposable and user-replaceable, with a life expectancy of up to 24 months depending on usage. The sensor is designed for use at atmospheric pressure (0 psi). The gas mixture to be analyzed must be regulated accordingly, and any potential for pressure or vacuum must be avoided.

2.5. Batteries

One 9-volt battery provides power. The battery is located inside the Analyzer and is user-replaceable. The battery should be removed any time the Analyzer will be stored without use for extended periods of time. Screen will blink alternately from "000" to "bAt" at start up when battery is low.



2.6. Flow Adapter Cap

The Analyzer includes a Flow Adapter Cap with flexible tubing and flow orifice. It attaches to the Sensor port and is sealed by an o-ring. It can be used to direct the gas sample flow to the Sensor via one of two methods:

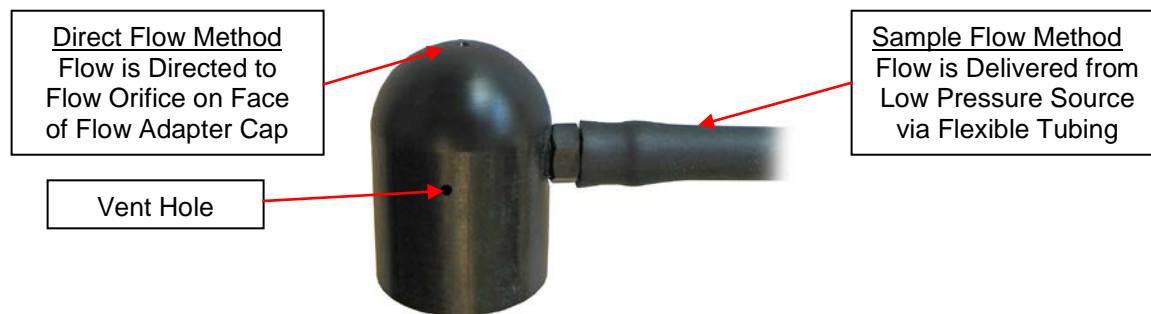

Flow to the sensor needs to be restricted to .5-1liter of pressure maximum. NuVair offers flow restrictors to accomplish this task. See appendix.

3.0 Calibration

Warning

Oxygen Analyzers must be calibrated before each use. Improper calibration may result in the use of incorrect breathing gas mixtures, which may cause serious injury or death to the person using the gas mixture.

Warning

Calibration or use of the Analyzer with a low battery may result in inaccurate readings. Inaccurate gas analysis can lead to serious personal injury or death.

Warning

When Analyzer calibration is performed at different atmospheric conditions than the gas being measured, a calibration correction value may be required. Improper calibration may result in the use of incorrect breathing gas mixtures, which may cause serious injury or death to the person using the gas mixture.

Notice

If the Analyzer has been subjected to a recent change in ambient temperature, allow it to stabilize for one hour before checking calibration.

Warning

During the warm up time if the oxygen percentage of the mixed gas flow is different from the value of calibration set in the instrument, a failed calibration is obtained and a wrong analysis value will be displayed.

3.1. Calibration Methods

Calibration should always be performed at the same temperature and humidity conditions as the gas being measured. This is not always possible, for example, in a tropical environment where dry breathing gas from a high-pressure scuba cylinder will be measured after Analyzer calibration has been performed in the warm, humid ambient air. Under these conditions a calibration correction value may be required, or dry air must be used for calibration. It may be required for the analyzer to be auto calibrated to a certified calibration gas.

Warning

Obtain proper training before attempting special calibration procedures. Improper calibration may result in the use of incorrect breathing gas mixtures, which may cause serious injury or death to the person using the gas mixture.

To assure the greatest accuracy for other applications, use the calibration gas concentration closest to the expected concentration in the gas being measured.

4.0 Operation

Prior to each Analyzer use:

- 1) Turn unit on by holding on/off button for 2 sec, until display shows “On”, after that the “Att” (Wait) message will be displayed for about 4 seconds, then the sensor auto-calibration procedure is started.
- 2) The auto-calibration last about 5 seconds; during this time the display will show the message “CAL” and “Att” alternatively. Be sure during this time the exposed to the gas mix with oxygen percentage as programmed in the O₂c (calibration) parameter (SEE PROGRAMMING PROCEDURE). By default, for simplicity, the O₂c value is set at 21% that corresponds to the percentage of Oxygen in free air in this case be sure that flows air on the sensor before switching on and during the warm up time.
- 3) At the end of the warming up and calibration time, the display will show the blinking value in mV read from the oxygen sensor during calibrations: the instrument is now ready to read oxygen concentration of the gas.
- 4) Connect the sensors flow adaptor to the gas. The flow rate of gas must equal 1 – 5 L/min. To produce this flow, a Flow Restrictor and Regulator may be required. See Spares and Accessories section. The display will now read the oxygen content continuously of the gas flow.
- 5) While the analyzer is displaying the oxygen percentage press the calibrate button for more than 1 second to initiate the mV output display mode. It is important to periodically monitor this value in order to confirm the sensor is working properly and not expired.

Warning

Gas, even under moderate pressures, can cause extreme bodily harm. Never allow any gas stream to be directed at any part of your body.

Tip: You can check the battery life and current temperature by holding Adjust button for 3 seconds. The display will alternate from battery life to current temperature (celcius) twice before returning the home screen.

⚠ Warning

Never expose the sensor to pressures above atmospheric pressure (0 psi) or you may cause damage to the sensor and/or receive false readings. Damaged Sensors will not provide accurate gas analysis. Inaccurate gas analysis can lead to serious personal injury or death.

4.1. Programming Procedures

Keep the “Prog” button pressed for more than two seconds and then release the button. “Pr” should display for two seconds and then the display will change to AL 1 and alternate with the 3 digit set value.

It is possible to program:

- **AL 1** Minimum alarm point expressed in % of oxygen concentration
- **AL 2** Maximum alarm point expressed in % of oxygen concentration
- **FSC** Value expressed in % of oxygen concentration corresponding to the current output full scale value (20mA). 20mA always correspond to 100 % oxygen concentration.
- **O2c** Oxygen sensor calibration point

At the end of the programming procedure the display will show “End” and the instrument will display the oxygen content of the gas mix.

Below are the actual screen views of each of the modes.



Program



First Alarm



Second Alarm



Full Scale Value



Oxygen Sensor
Calibration



21% reading

4.2. Alarm Setting (AL 1 & AI 2)

- 1.) Press the “Prog” button for more than two seconds and then release the button.
On the display will appear “Pr” for two seconds, then “AL1” will appear and be ready for changing the value of the first alarm point. After a second the display will show the value of “AL1” O₂% (0% default) current setting.
- 2.) The blinking digit shows the cursor position.
- 3.) Press the “Prog” button to increase the value (from 0 to 9)
- 4.) Press the “Adjust” button to move the cursor to the next digit, the “Adjust” button will be used to cycle through the rest of the digits.
- 5.) To complete your entry and save the O₂% value, press the “On/Off” button. You will then automatically jump to “AL 2” programming view.
- 6.) Repeat steps 3 through 5 to modify and save the “AL 2” O₂% desired value (100% default).
- 7.) Once programming of “AL 2” is complete you will be in the “FSC” Value Screen and ready for programming this value. To jump to the end continue to press the “On/Off” button until the end screen appears.

4.3. Full Scale Value Setting (FSC)

Once the alarms have been set the Pro O₂ Alarm Analyzer goes to “FSC” view so that you can change the analog full scale value. It is not necessary to modify this value which is factory set at 100. This is the Oxygen concentration corresponding to 20 mA on the analog output. 4mA is the value at 0% of Oxygen. This value can be changed in the same manner as the Alarm settings:

- 1.) Press the “Prog” button for more than two seconds and then release the button.
On the display will appear “Pr” for two seconds, then “AL 1” will appear. Press the On/Off button to cycle through the Alarm settings until you reach the “FSC” view. The “FSC” screen and a 3 digit value will alternate for a few seconds and the Pro O₂ Alarm Analyzer will be ready for adjusting the “FSC” Value.
- 2.) The blinking digit shows the cursor position.
- 3.) Press the “Prog” button to increase the value (from 0 to 9)
- 4.) Press the “Adjust” button to move the cursor to the next digit, the “Adjust” button will be used to cycle through the rest of the digits.
- 5.) To complete your entry and save the FSC value, press the “On/Off” button. You will then automatically jump to “O2c” programming view. To continue pass this to the end press the On/Off button until the “End” screen appears.

4.4. Calibration Oxygen Value (O2c)

After the “O2c” is set the Pro O₂ Alarm Analyzer goes to “O2c”, this is the current Oxygen calibration value default is 21%. It is not necessary to modify this value. The display alternates between “O2c” and the current value (21% default).

Press the “Prog” button for more than two seconds and then release the button.

On the display will appear “Pr” for two seconds, then “AL 1” will appear. Use the On/Off button to cycle through the various settings until you reach the “O2c” screen.

The 3 digit value will alternate with the “O2c” screen for a few seconds and the Pro O₂ Alarm Analyzer will be ready for adjusting the “O2c” Value.

- 1.) The blinking digit shows the cursor position.
- 2.) Press the “Prog” button to increase the value (from 0 to 9)
- 3.) Press the “Adjust” button to move the cursor to the next digit, the “Adjust” button will be used to cycle through the rest of the digits.
- 4.) To complete your entry and save the O2c value, press the “On/Off” button. You will then automatically jump to the “End” screen.

Warning

The oxygen calibration value will be the same value of the calibration set when the instrument is switched on. During the warm up time if the oxygen percentage of the gas flowing across the sensor is a different value of calibration set in the instrument, a failed calibration is obtained and the wrong gas percentage will be displayed. Wrong oxygen analysis may lead to death.

Warning

The calibration value of the Pro O₂ Alarm is factory set at 21% and any adjustments to this value will change the analyzers ability to properly ready the % of oxygen in a gas. A wrong value in this parameter will give a wrong reading of O₂ concentration and the instrument will not be accurate. All the analysis concentration shown on the display will be wrong. If you modify this setting you must test the analyzer for accuracy with certified testing gas. Do not modify this value. Wrong oxygen analysis may lead to death.

5.0. Threshold Alarms

Should the Oxygen reading exceed the threshold alarms (AL1 or AL2) the instrument will go into alarm mode and will activate the (optional) relays output (open collector max 100mA) and the internal buzzer. The display will show the trespassed alarm and the actual measured value. To stop the audible alarm, press any key. In this event the Pro O₂ Alarm Analyzer will remain in alarm mode until the analyzed value goes below the alarm.

The relay output typically is used to shut down the compressor. Nuvair can supply the necessary components to adapt your compressor to the relay or provide them at the time of install on a new compressor.

6.0 Powering on and warming up

Press the On/Off button for more than one second, until the display shows “on”, after that the “Att” (wait) message will be displayed for about 4 seconds, then the sensor auto-calibration lasts about 5 seconds; during this time the display will show the messages “CAL” and “Att” alternatively.

Be sure that during this time the sensor is exposed to the gas mix with the oxygen percentage as programmed in the “O2c” parameter (see programming procedure). By default the parameter is set at 21% by default that corresponds to the percentage of oxygen in free air, be sure that the air flow at this time across the sensor is 21% oxygen before turning on the analyzer.

Warning

During the warm up time if the oxygen percentage of the gas flowing across the sensor is a different value of calibration set in the instrument, a failed calibration is obtained and the wrong gas percentage will be displayed. Wrong oxygen analysis may lead to death.

6.1 Powering Off

At the home or gas reading screen, hold down the On/Off button for a couple of seconds. The Analyzer will display “OFF” and then go blank.



7.0 Factory Reset

In case it is necessary to reset the Pro O₂ Alarm Analyzer to the factory settings, power on the Analyzer pressing at the same time for more than one second the “On/Off” and “Adjust” buttons. On the display will appear “res” and the instrument will go to the reading page.

Warning

In case of reset, the instrument will delete all the alarms settings, the full scale value, and any new conversion value of Oxygen sensor will be reset to factory settings. Before using again the instrument, it may be necessary to program again the alarm values, the full scale value, and the Oxygen sensor calibration if changed. All the analysis concentration shown on the display would be wrong. Wrong Oxygen analysis may lead to death.

8.0. Maintenance

8.1. Analyzer Care

Warning

Analyzers immersed in liquid or stored in wet environments may not operate properly. This may result in incorrect readings. Incorrect gas analysis may result in personal injury or death.

Warning

Protect the analyzer from excessive shock and impact. Excessive shock and impact may result in incorrect readings. Incorrect gas analysis may result in personal injury or death.

Warning

Protect the analyzer from exposure to hyperbaric environments. Exposure to hyperbaric environments may result in incorrect readings. Incorrect gas analysis may result in personal injury or death.

- Do not clean Analyzer with anything other than a damp soft cloth.
- Do not immerse in liquid, leave unprotected outside, or store in a wet environment.
- Protect Analyzer from excessive shock and impact.
- Protect Analyzer from excessive exposure to sunlight and extreme temperatures.
- Do not use the Analyzer in a hyperbaric environment.

8.2. Battery Replacement

⚠ Notice

Be sure to dispose of spent, leaking, or damaged Battery properly, according to local regulations.

The following pictures illustrate the steps required to replace the batteries in the Analyzer.

Step 1. Remove
Screws

Step 2. Remove
Back Cover

Step 4. Replace
Back Cover -
Do Not Pinch
Wires

Step 5.
Reinstall
Screws



Step 3.
Remove &
Replace Old
Battery

Step 6. Turn
Analyzer On

Step 7.
Perform
Calibration



8.3. Sensor Replacement

You may take note of your sensor number before installing a new sensor serial number.

Sensor Serial
Number



⚠ Caution

Be sure to dispose of spent, leaking, or damaged Sensors properly, according to local regulations.

⚠ Danger

Do not swallow (ingest) either the electrolyte from the Sensor or the Sensor itself. The Potassium hydroxide chemical contained in the Sensor will cause severe injury or death. If electrolyte or the Sensor is swallowed, seek medical attention immediately.



Warning

If after handling the Analyzer or Sensor, you find that your fingers or other parts of your body feel “slippery” or the skin or eyes sting, immediately flush affected area with clean, fresh water for at least 15 minutes. The stinging or slippery sensation is an indication of a leaking Sensor. The Potassium Hydroxide chemical contained in the Sensor can cause severe injury or death. Seek immediate medical attention if eye contact is made or skin stinging persists.

8.4 Handling Sensors

Replacement Sensors are supplied in sealed bags. Normally Sensors do not present a health hazard. Before opening the bag, check that the electrolyte has not leaked. However, if electrolyte leakage has occurred, do not open bag. Dispose of Sensor properly or return for replacement. If electrolyte leakage occurs while the Sensor is in service, use rubber gloves and chemical splash goggles for handling. Rinse contaminated surfaces thoroughly with water.

Electrolyte First Aid Procedures

- Ingestion - Drink a large volume of fresh water. Do not induce vomiting. Get immediate medical attention.
- Eye Contact - Flush eyes with clean, fresh water for at least 15 minutes and get medical help immediately.
- Skin Contact - Flush the affected area with clean, fresh water for at least 15 minutes and removed contaminated clothing. If stinging persists get medical attention.



Warning

Do not try to disassemble the sensor. Sealed unit contains caustic liquid (KOH) which may cause severe burns to skin and eyes. In case of contact, flush 15 minutes with water. For contact to eyes also get medical attention. Do not wet in any case. If not properly cured the eyes may have permanent damages.

The following pictures illustrate the steps required to replace the Sensor in the Analyzer.

Step 1.
Remove Flow
Adapter Cap



Step 2.
Remove
Screws

Step 3.
Remove
Back



Step 4.
Disconnect
Electrical
Connector



Step 5. Remove
Old Sensor from
Case by
Unscrewing

Step 6. Replace
with New
Sensor



Step 7. Remove
Shorting Plug from
Sensor Electrical
Connector & Reconnect

Note: Reversing Polarity
Will Cause Display to
Read Negative



Step 8.
Replace
Front Cover
- Do Not
Pinch Wires

Step 9.
Reinstall
Screws



Step 10. Replace
Flow Adapter Cap

Step 11. Turn
Analyzer On

Step 12. Check
Calibration



9.0 Analyzer Sensor Specifications

Sensor Type:	Electrochemical (Galvanic)
Electrical Connector:	3.5 mm Molex Jack
Range:	0-100.0% Oxygen (0-1 ATA PPO ₂)
Display Accuracy:	+/- 1%
Expected Sensor Life, Room Air:	0-24 Months @ ambient air
Output Signal:	11+- 3 millivolt @ dry ambient air 74°F (23°C)
Power:	9 V alkaline battery, rechargeable lithium battery, 110/220 V wall plug-in or 12 V DIN rail (panel mount only)
Response Time:	<15 seconds for 90% response; <25 seconds for 97% response
Drift:	< 1% volume O ₂ / month @ air
Operating Temperature:	41 to 86°F (5 to 30°C)
Storage Temperature:	5 to 122°F (-5 to 50°C)
Pressure:	750 to 1250 hPa
Repeatability:	± 1% volume O ₂ @ 100% O ₂ applied for 5 min.
Zero Offset Voltage:	= 200 uV in 100% N ₂ , applied for 5 min.
Influence of Humidity:	-0.03% rel. O ₂ reading /%RH
Humidity:	up to 95% rh, non-condensing
Temperature Compensation:	NTC
Interferences:	according to DIN EN 12598 and ISO 7767
Material in contact media:	PA, PPS, PTFE, stainless steel

In the interest of product improvement these design specifications may change without notice.

Note: All specifications are at ambient / sea level, 77°F / 25°C

10.0 Troubleshooting

SYMPTOM	REASON	SOLUTION
Battery symbol	Low Battery	Change the battery
No display	Switched off Bad connection Low Battery	Switch on Check display/ battery connection Change the battery
Reading erratic	Pressure on sensor Radio transmission Sensor old or faulty Condensation on sensor.	Check flow Move unit away Change sensor Dry in air
Display segments missing	Display faulty	Return to dealer
Reading drifts	Rapid temperature change	Stabilize temperature & recalibrate

11.0 Spares and Accessories

P/N 9507M
 Replacement
 Sensor for Pro
 O₂ Alarm
 Handheld and
 Panel Mount



Flow Restrictors and Regulators (Pro O₂)

A variety of Flow Restrictors and Pressure Regulators for the Sample Flow Method are available from NuVair, all calibrated to produce a flow rate of 1 – 5 L/min with a Regulator output of 100 – 160 psi

Universal Flow Restrictors are used for most applications and are typically provided complete with Regulator.

When analyzing Scuba Cylinder gases, special Flow Restrictors can be used to obtain the sample gas directly from the BC inflator hose. A variety of BC Flow Restrictors are available to fit the different types of inflator hose QD fittings used.

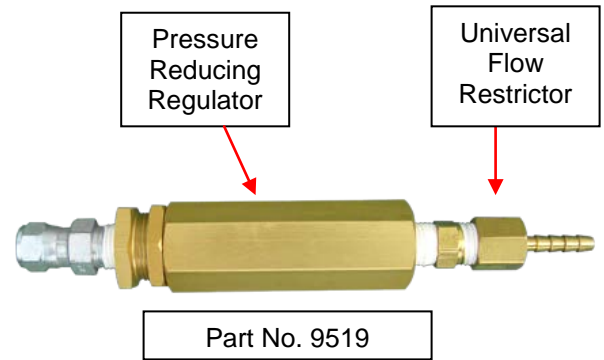

1/4" FNPT Flow Restrictor
 Part - 9518



Standard Flow Restrictor
 Part - 9518-STD



Mares™ Flow Restrictor
 Part – 9518-MARES



ScubaPro™ Flow Restrictor
 Part – 9518-SCUBAPRO

12.0 Relay Output Schematics

4-20mA Connections: The relay output uses a special “Mini Jack” plug that can be purchased separately from Nuair. Insert the plug into the output jack. Connections diagram below for additional wiring.

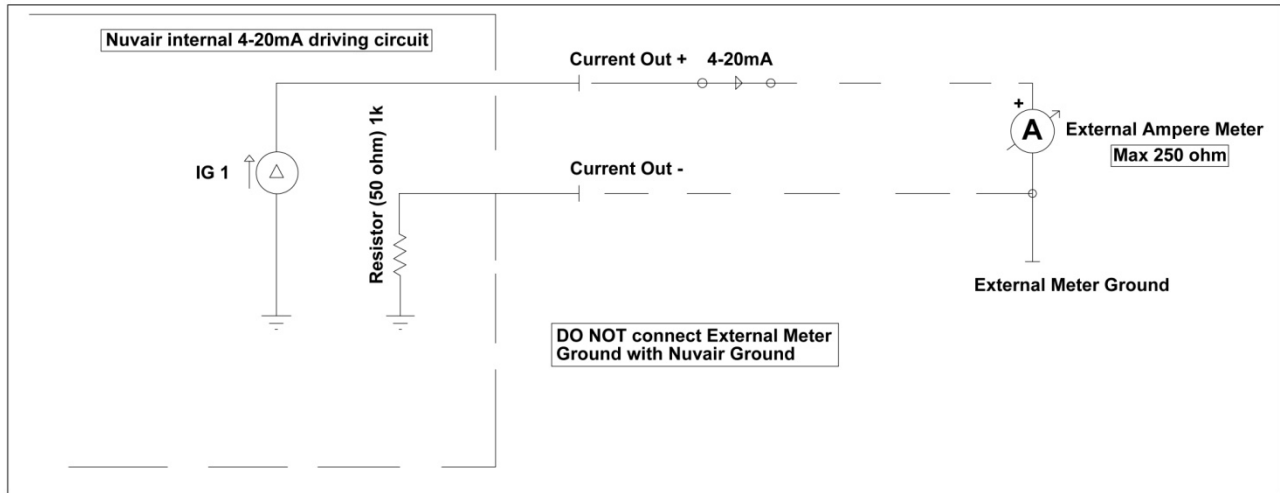

⚠ Warning

The plug should be connected or disconnected when the instrument is switched off, or the instrument will automatically switch off.

Open Collector Connections:

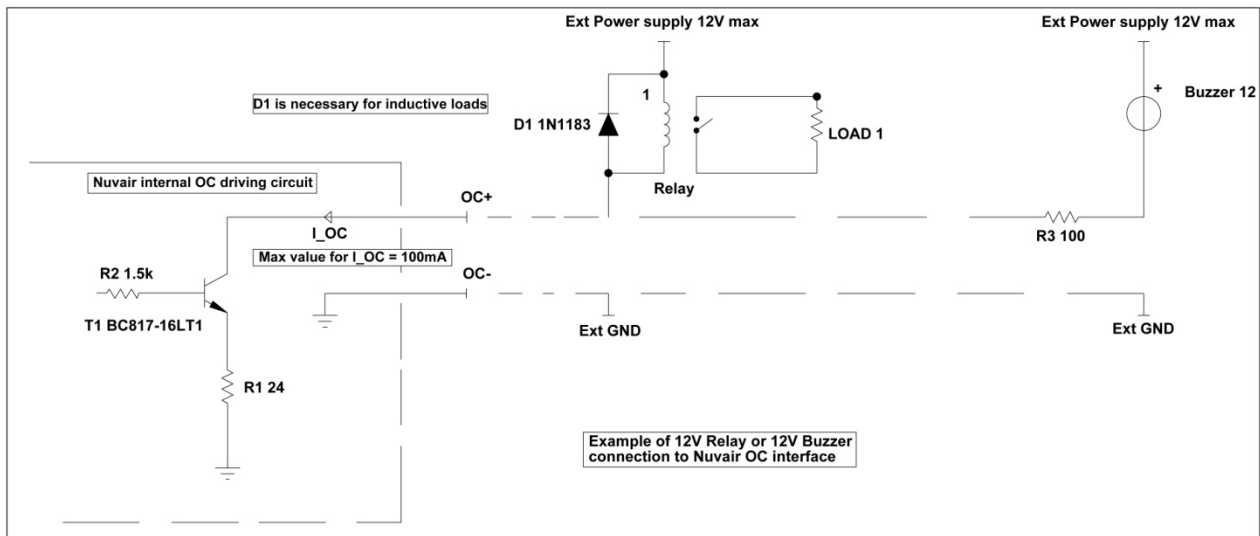

NUVAIR Pro O₂ Alarm Warranty

Nuvair extends a limited warranty, which warrants the Pro O₂ Alarm to be free from defects in materials and workmanship under normal use and service for a one year (12 months). The Pro O₂ Alarm **Sensor** is under warranty according to the pro-rated terms as set forth below. This warranty is non-transferable.

Nuvair will, at its discretion and according to the terms as set forth within, replace or repair any materials which fail under normal use and service and do not exhibit any signs of improper maintenance, misuse, accident, alteration, weather damage, tampering, or use for any other than the intended purpose. Determination of failure is the responsibility of Nuvair, which will work together with the customer to adequately address warranty issues. When any materials are repaired or replaced during the warranty period, they are warranted only for the remainder of the original warranty period. This warranty shall be void and Nuvair shall have no responsibility to repair or replace damaged materials resulting directly or indirectly from the use of repair or replacement parts not approved by Nuvair.

Pro-Rated Terms:

Nuvair warrants the oxygen sensor for a period of twenty-four (24) months from date of purchase. The warranty covers the sensor only and is prorated as follows:

- | | |
|------------------|----------------------|
| • 0 – 12 Months | 100% parts and labor |
| • 13 – 18 Months | 50% off sensor only |
| • 19 – 24 Months | 25% off sensor only |
| • 24+ Months | no warranty coverage |

A warranty registration card, supplied with system documentation, must be filled out and submitted to Nuvair for the warranty to be registered. If the warranty registration card is not received within ten (10) days of purchase, the warranty will begin with the date of manufacture by Nuvair.

Maintenance Items:

Any materials which are consumed, or otherwise rendered not warrantable due to processes applied to them, are considered expendable and are not covered under the terms of this policy. This includes the 9-volt battery used in the Pro O₂ Alarm.

Return Policy:

Application for warranty service can be made by contacting Nuvair during regular business hours and requesting a Return Material Authorization number. Materials that are found to be defective must be shipped, freight pre-paid, to the Nuvair office in Oxnard, California. Upon inspection and determination of failure, Nuvair shall exercise its options under the terms of this policy. Warranty serviced materials will be returned to the customer via Nuvair's preferred shipping method, at Nuvair's expense. Any expedited return shipping arrangements to be made at customer's expense must be specified in advance.

Limitation of Warranty and Liability:

Repair, replacement or refund in the manner and within the time provided shall constitute Nuvair's sole liability and the Purchaser's exclusive remedy resulting from any nonconformity or defect. Nuvair shall not in any event be liable for any damages, whether based on contract, warranty, negligence, strict liability or otherwise, including without limitation any consequential, incidental or special damages, arising with respect to the equipment or its failure to operate, even if Nuvair has been advised of the possibility thereof. Nuvair makes no other warranty or representation of any kind, except that of title, and all other warranties, express or implied, including warranties of merchantability and fitness for a particular purpose, are hereby expressly disclaimed. No salesman or other representative of Nuvair has authority to make any warranties.

Notes:



Nuvair
Phone +1 805 815 4044
Fax +1 805 486 0900
1600 Beacon Place
Oxnard, CA 93033
USA
info@nuvair.com
www.nuvair.com

Revision 07.18